

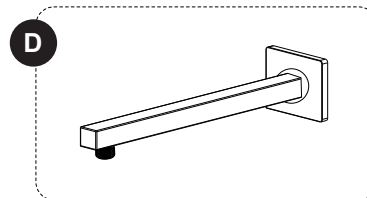

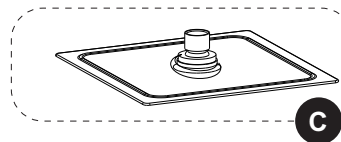

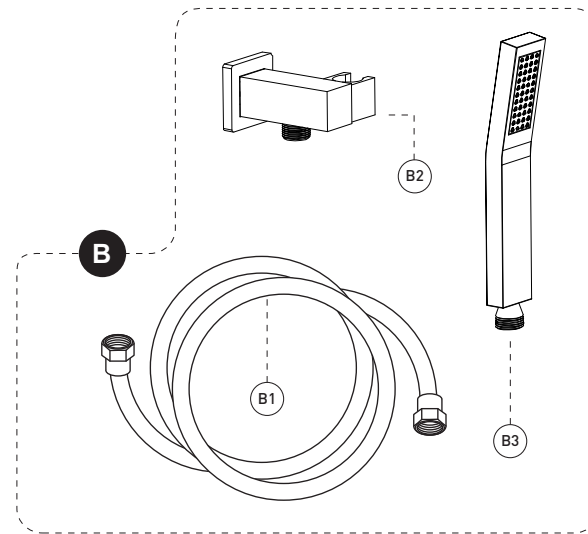

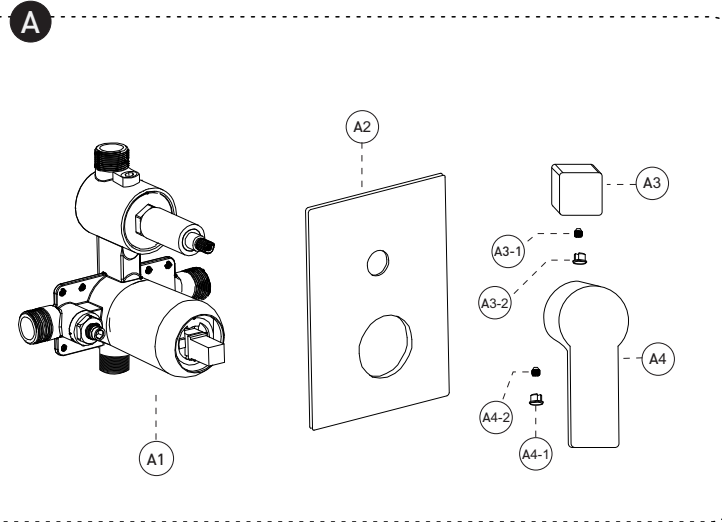

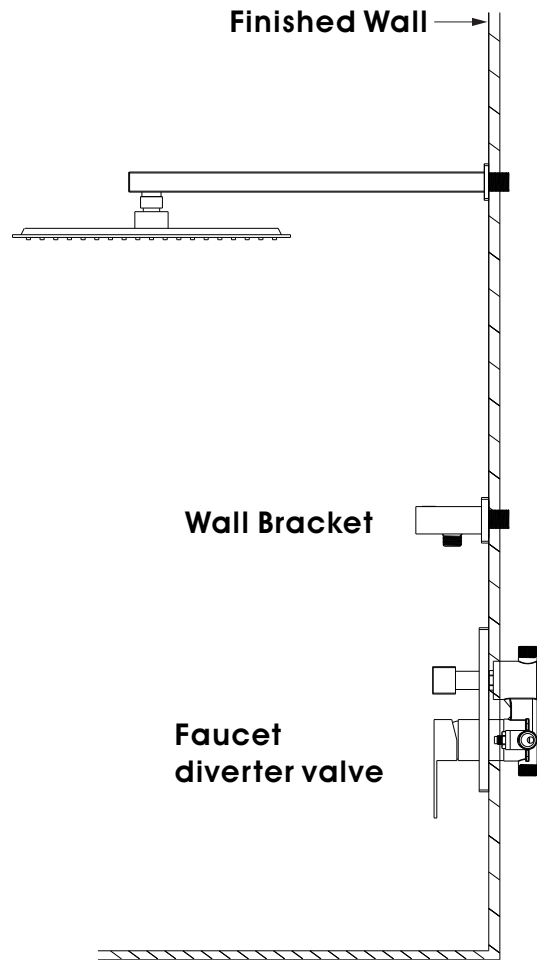









## PRODUCT DRAWING

**A**



No.	Description				
<b>A</b>	Pressure balanced diverter valve				
<b>A1</b>	Valve				
<b>A2</b>	Face plate with sealjoint				
<b>A3</b>	Diverter knob kit				
<b>A3-1</b>	Allen screw (A-3 included )				
<b>A3-2</b>	Trim cap (A-3 included )				
<b>A4</b>	Shower valve handle				
<b>A4-1</b>	Trim cap (A-4 included )				
<b>A4-2</b>	Allen screw (A-4 included )				
<b>B</b>	Handheld Shower Kit with Flexible Hose				
<b>B1</b>	Flexible hose				
<b>B2</b>	Wall Bracket				
<b>B3</b>	Handheld Shower				
<b>C</b>	Shower head				
<b>D</b>	Shower arm and flange kit				
<b>Z</b>	Accessories Package				
<table border="1"> <thead> <tr> <th>For Repair And Warranty (Spare Parts)</th> <th>For Installation (Spare Parts)</th> </tr> </thead> <tbody> <tr> <td>    </td> <td>    </td> </tr> </tbody> </table>		For Repair And Warranty (Spare Parts)	For Installation (Spare Parts)	  	  
For Repair And Warranty (Spare Parts)	For Installation (Spare Parts)				
  	  				

## SHOWER SYSTEM FAUCET

Installation instruction



**MB/BN/BG/CH/ORB**

### CARE INSTRUCTIONS

Rinse the product with clear water. Dry the product with a soft cloth.

### DO NOT:

Use abrasive cleansers, cloths, or paper towels. Use any cleaning agents containing acid, polish, wax, alcohol, ammonia, bleach, solvent or any other corrosive or harsh chemical cleansers.

# INSTALLATION STEPS

## ! IMPORTANT

We recommends using a professional plumber for all installtion and repair. Please inform yourself about the canadian plumbing code`s regulations and your local municipality plumbing codes before installlation.the canadian plumbing code requires the installation of urge arresting devices to eliminate water hammering.allow an adequate opening in orderto easilyaccess connections or other plumbing devicesfor maintenance or repair.

### RECOMMENDED TOOLS



\* Apply plumber's putty under the plastic cover deck plecta to seal your installation.  
Appliquez du mastic pour plombier sous la sous-plaque de plastique pour rendre votre installation étanche.

### CONNECTION ADVICE

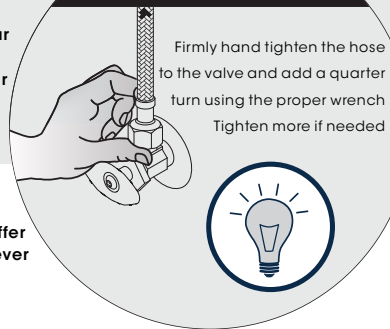

The model shown in the installation steps may differ from the one in box however connection type and installation steps are the same.

### BEFORE YOU BEGIN

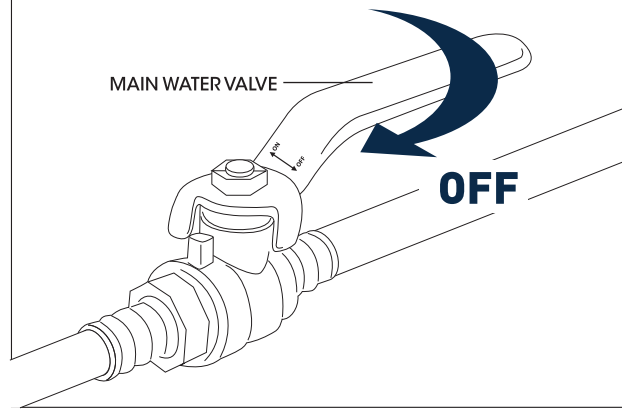

### INSTALLATION WAY

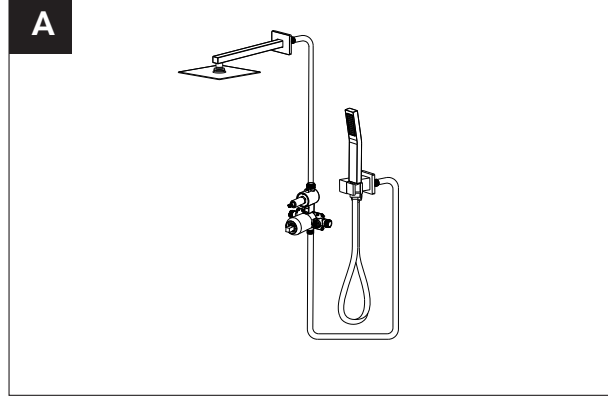

2

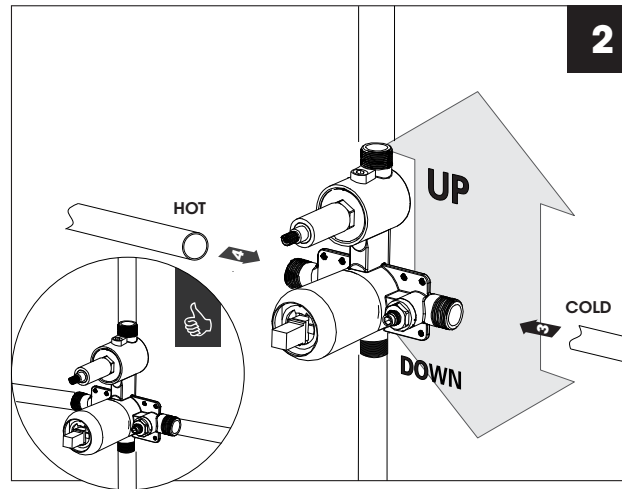

5

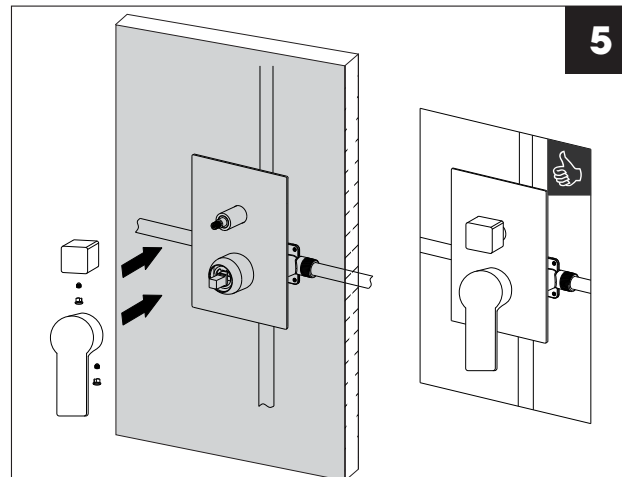

HEAD SHOWER

3

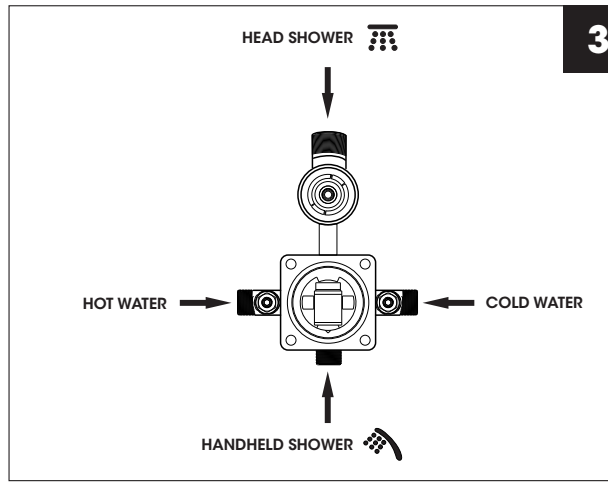

### HEAD SHOWER

6

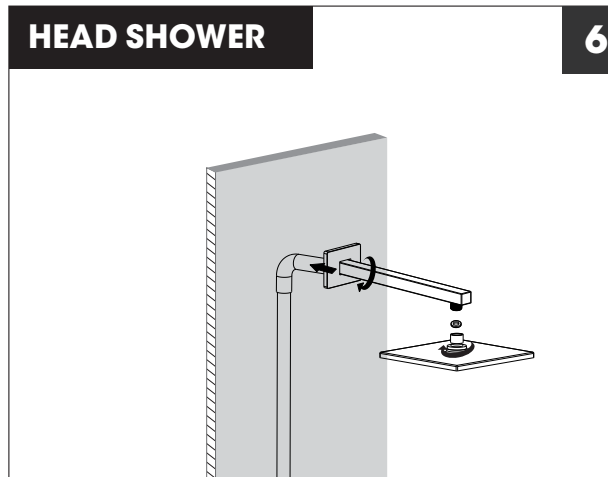

### HANDHELD SHOWER

7

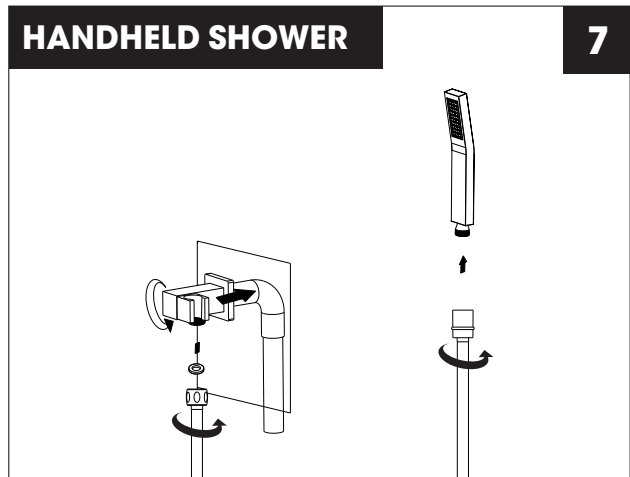

Rough-in-Installation primaire



WHEN USING A HANDSHOWER, IT NEEDS TO BE CONNECTED TO THE TOP OUTLET

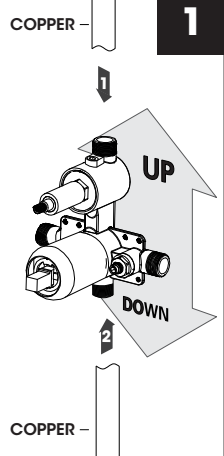
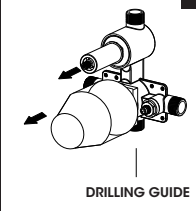

1

4

