

# M02 OPERATION INSTRUCTIONS

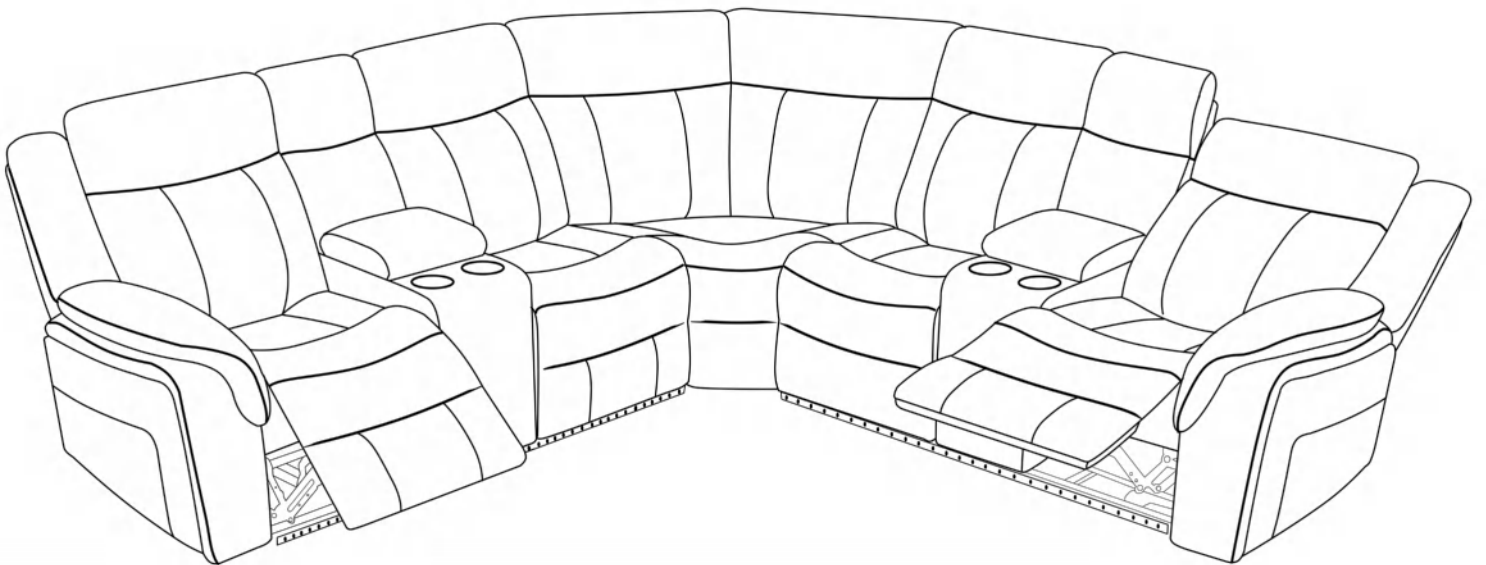

# M02 LAF LOVESEAT ASSEMBLY INSTRUCTIONS

Place the Left / Right Backrest(B,D) to the Loveseat Assembly(A), place the Left Wing(E) to the Left Brackrest(B), align with the metal brackets on each piece, then slowly lower the backrest until the metal brackets snap into the locked position side to the Recliner Loveseat Assembly(A). Install the Console Backrest(C) to the Recliner Loveseat Assembly(A), Connect the power cord(G), product is now completed.

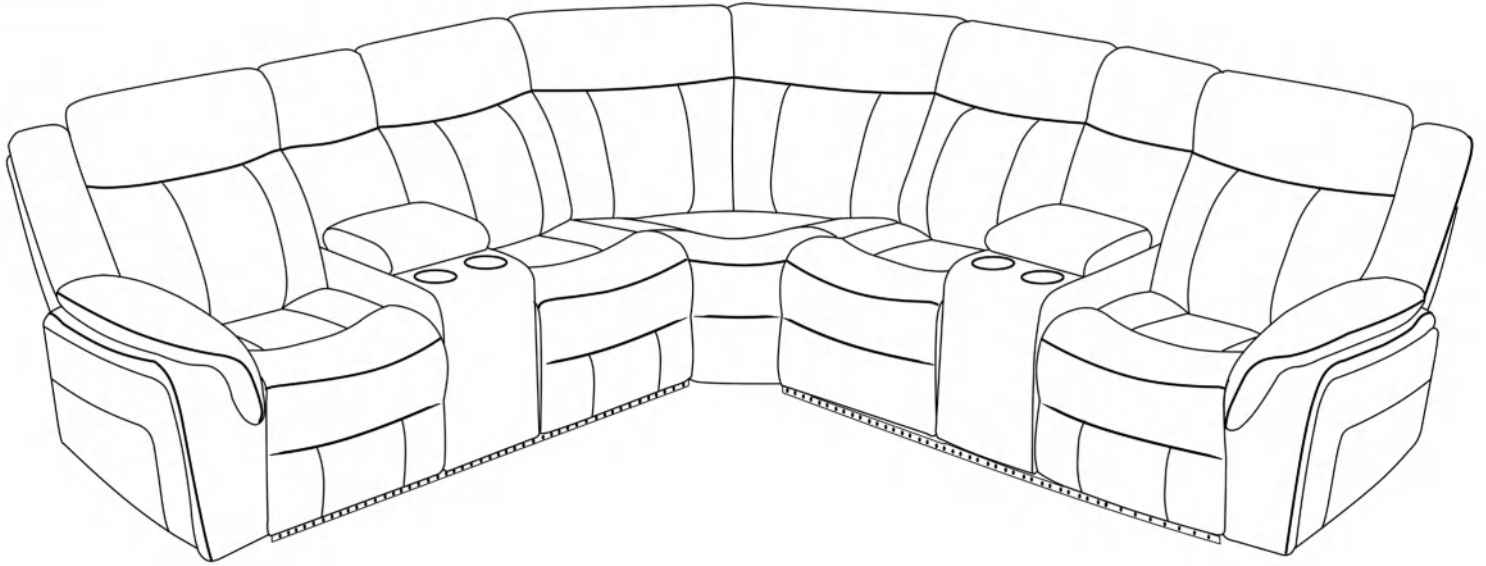
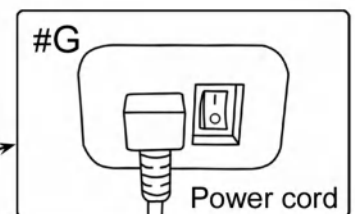
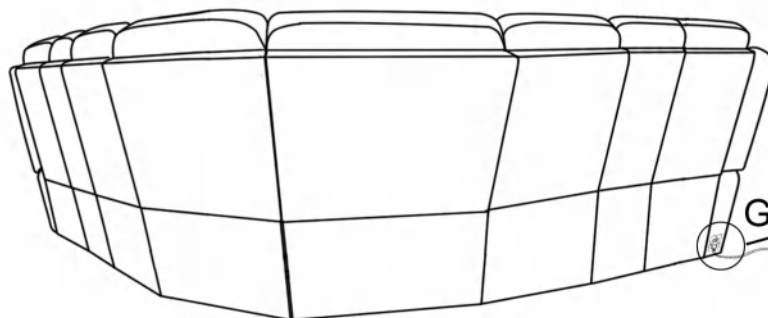
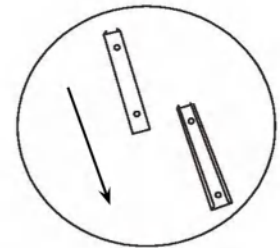
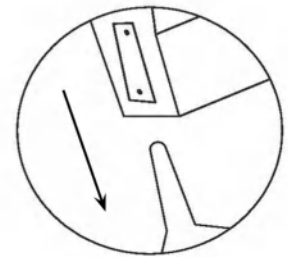
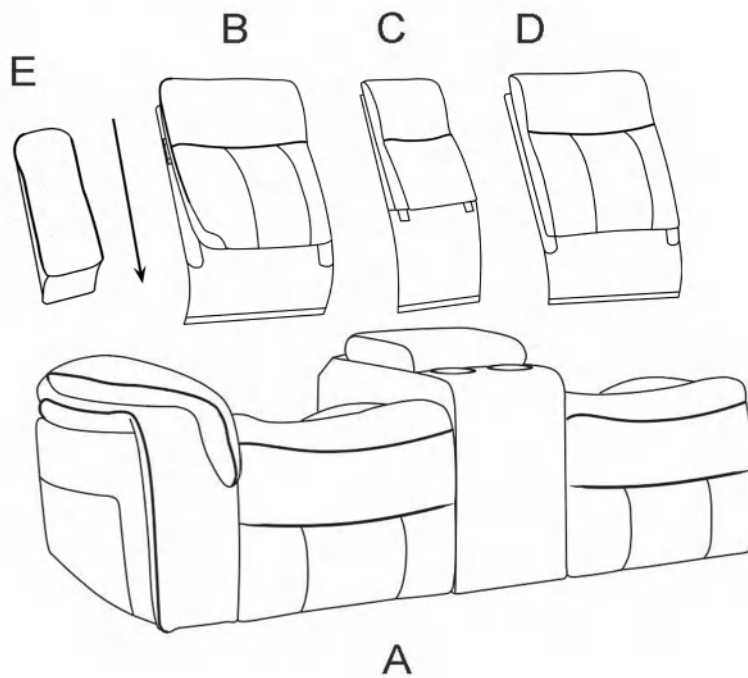
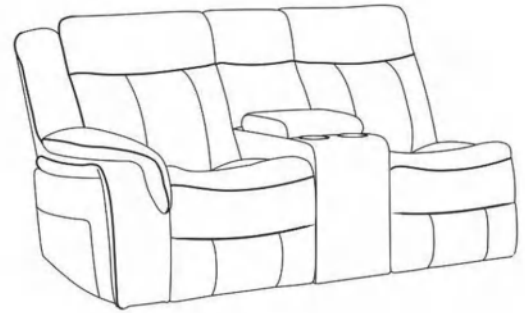

# PARTS LIST

**A** Recliner Loveseat Assembly(1PC)

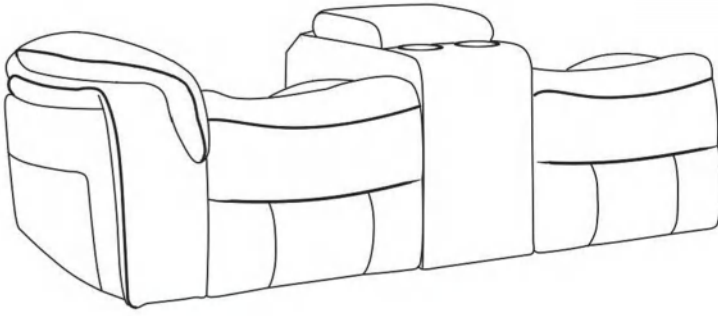

**B** Left Backrest(1PC)

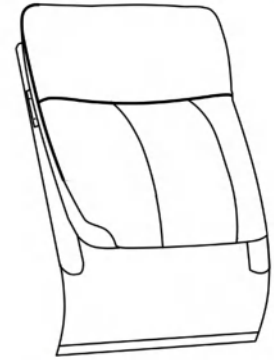

**C** Console Backrest (1PC)

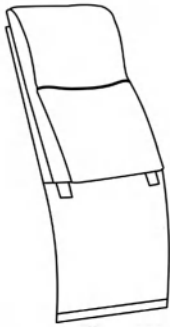

(Packed underneath the bottom of console)

**D** Right Backrest(1PC)

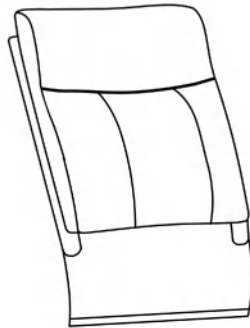

**E** Left Wing(1PC)



**F** Power Supply(1PC)



(Packed in Console area)

**G** Power cord(1PC)



(Packed in Console area)

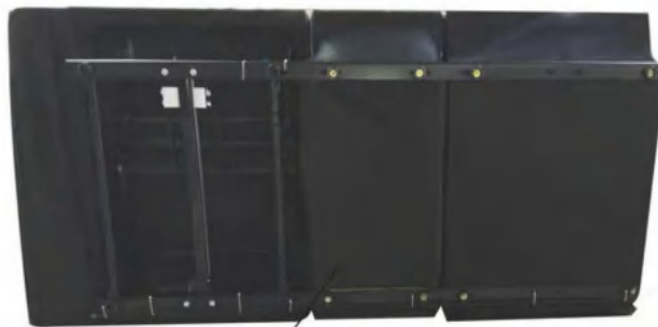

Console backrest inside

# Parts For M02 LAF Loveseat

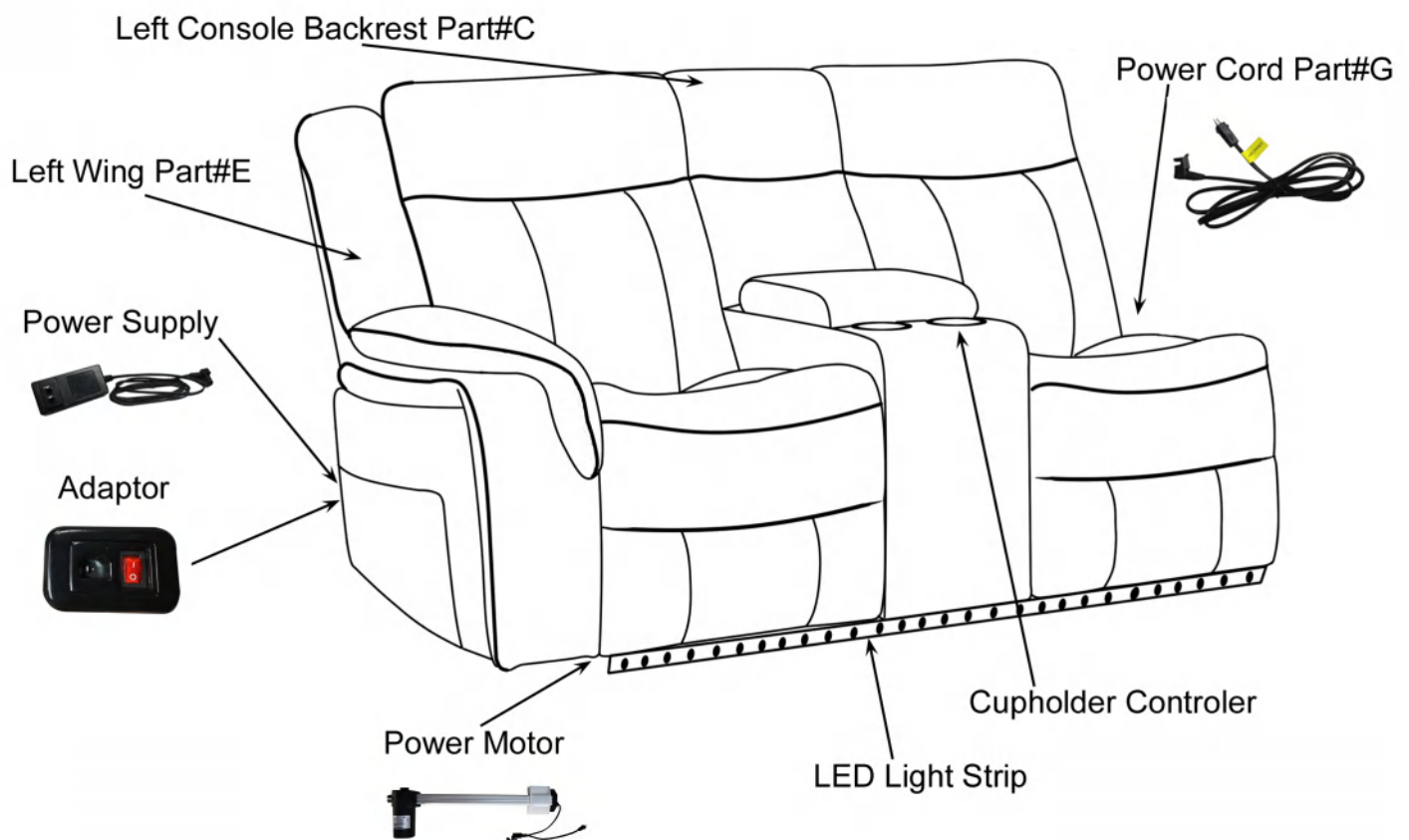

## PRODUCT DETAILS

Product Size	68"L x 36"W x 40"H
Carton Size	68"L x 30"W x 26"H
Net Weight	141 lbs
Gross Weight	154 lbs
Cuft	30.69'

## FABRIC CONTENT: POLYESTER 100%

This fabric is machine washable.  
 Allow +/- 3% residual shrinkage.  
 Do not use cleaning products containing brightening agents.

# UM02 RAF LOVESEAT ASSEMBLY INSTRUCTIONS

Place the Left / Right Backrest(B,D) to the Loveseat Assembly(A), place the Right Wing(E) to the Right Backrest(D), align with the metal brackets on each piece, then slowly lower the backrest until the metal brackets snap into the locked position side to the Recliner Loveseat Assembly(A). Install the Console Backrest(C) to the Recliner Loveseat Assembly(A), Connect the power cord(G), product is now completed.

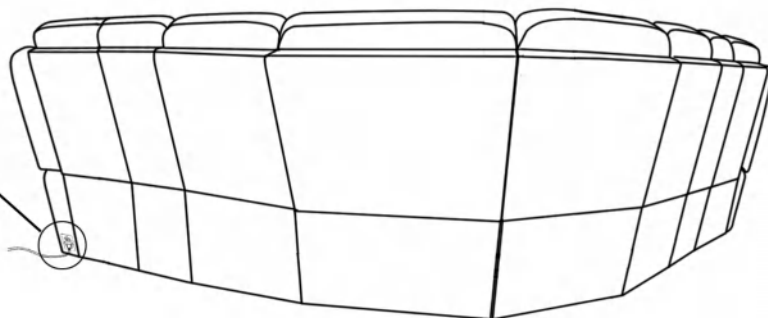
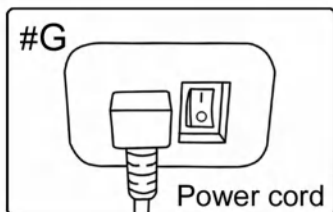
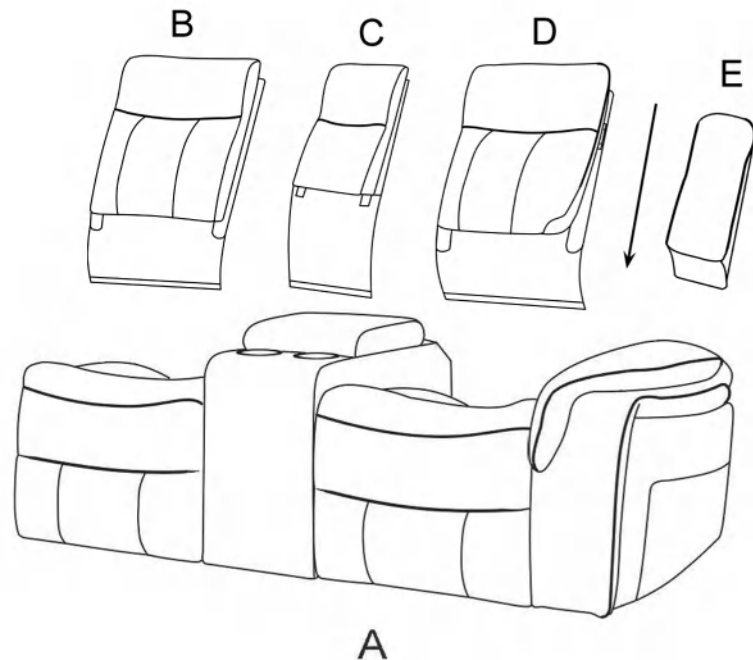
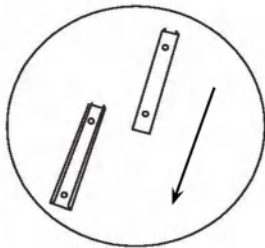
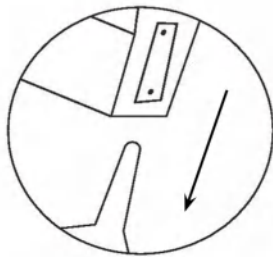
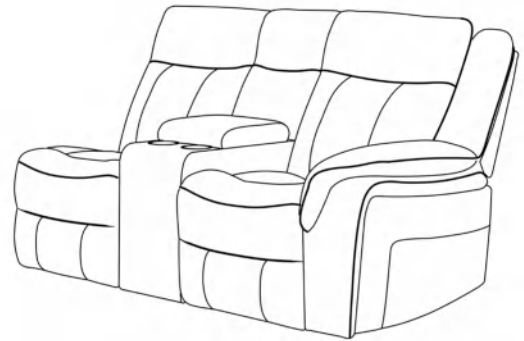



# PARTS LIST

**A** Recliner Loveseat Assembly(1PC)

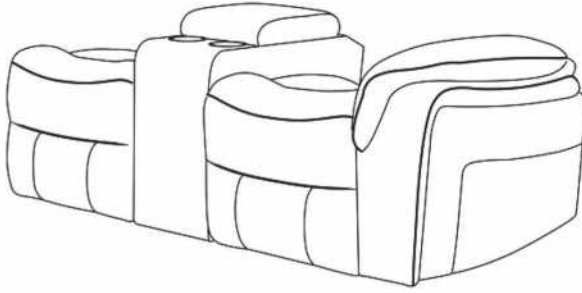

**B** Left Backrest(1PC)

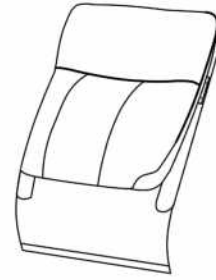

**C** Console Backrest (1PC)

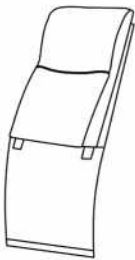

(Packed underneath the bottom console)

**D** Right Backrest(1PC)

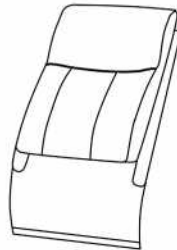

**E** Right Wing(1PC)



Console backrest inside

# Parts For RAF Loveseat

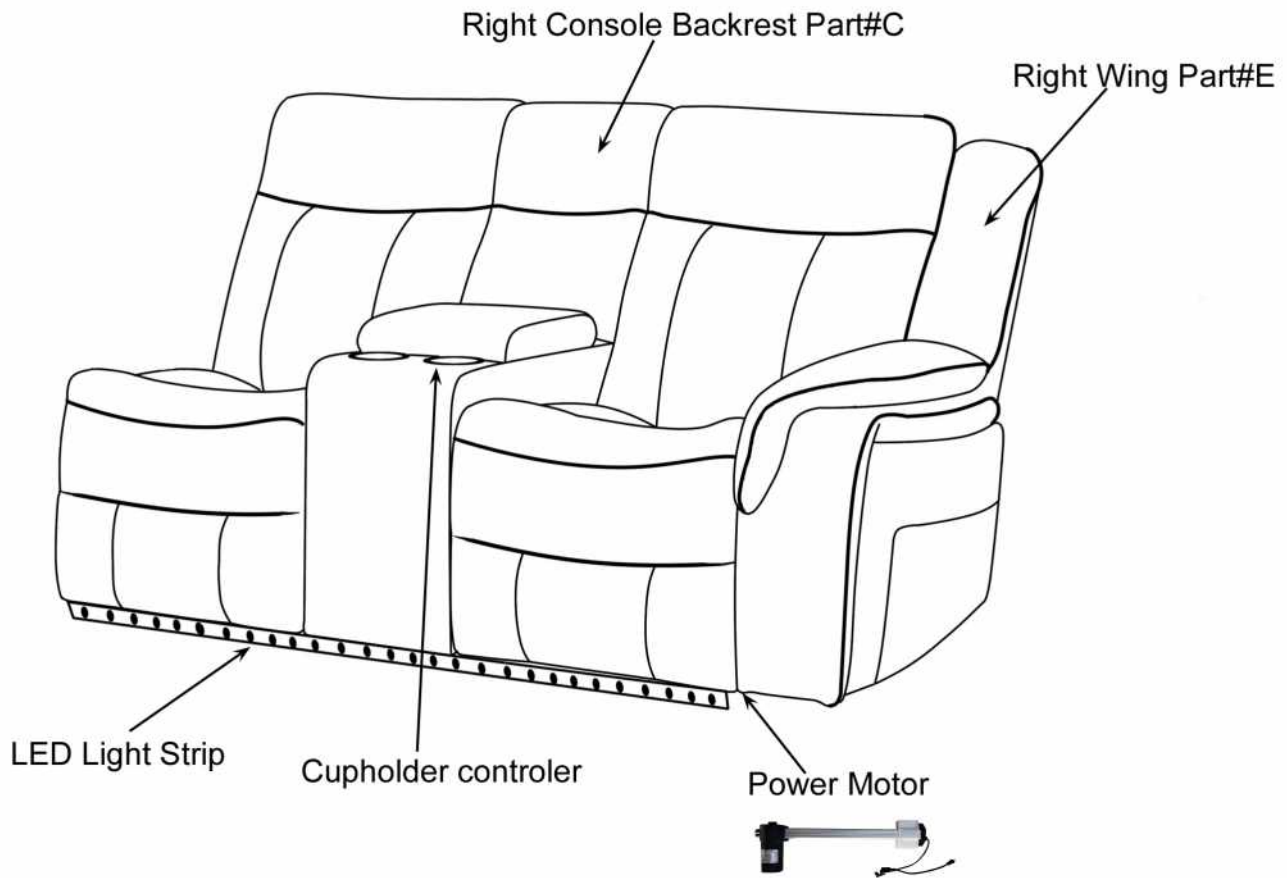

## PRODUCT DETAILS

Product Size	68"L x 36"W x 40"H
Carton Size	68"L x 30"W x 26"H
Net Weight	141 lbs
Gross Weight	154 lbs
Cuft	30.69'

## FABRIC CONTENT: POLYESTER 100%

This fabric is machine washable.  
 Allow +/- 3% residual shrinkage.  
 Do not use cleaning products containing brightening agents.

# M02 WEDGE ASSEMBLY INSTRUCTIONS

Place the Left / Right Backrest(B,C) to the Wedge seat Assembly(A), align with the metal brackets on each piece, then slowly lower the backrest until the metal brackets snap into the locked position side to the Wedge Assembly(A), product is now completed.

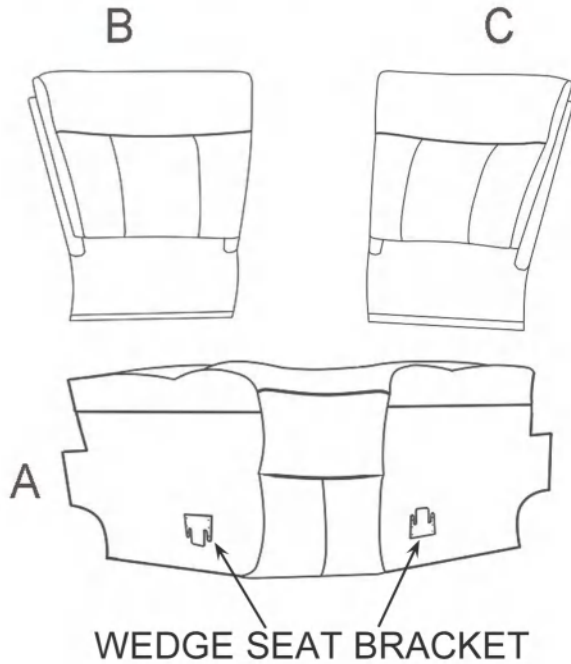
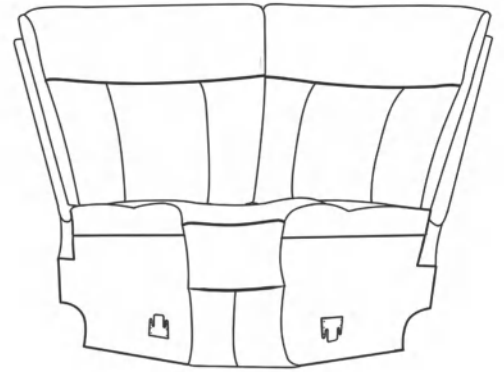

## PARTS LIST

<b>A</b>	Wedge Seat(1PC)	<b>B</b>	Left Backrest(1PC)	<b>C</b>	Right Backrest(1PC)



WEDGE SEAT DETAILS	
Product Size	59"L x 35"W x 19"H
Carton Size	44.25"L x 33.5"W x 18.25"H
Net Weight	40 LBS
Gross Weight	48 LBS
Cuft	15.66'

WEDGE BACKREST DETAILS	
Product Size	35"L x 29"W x 10"H
Carton Size	36"L x 30"W x 20"H
Net Weight	31 LBS
Gross Weight	37 LBS
Cuft	12.5'

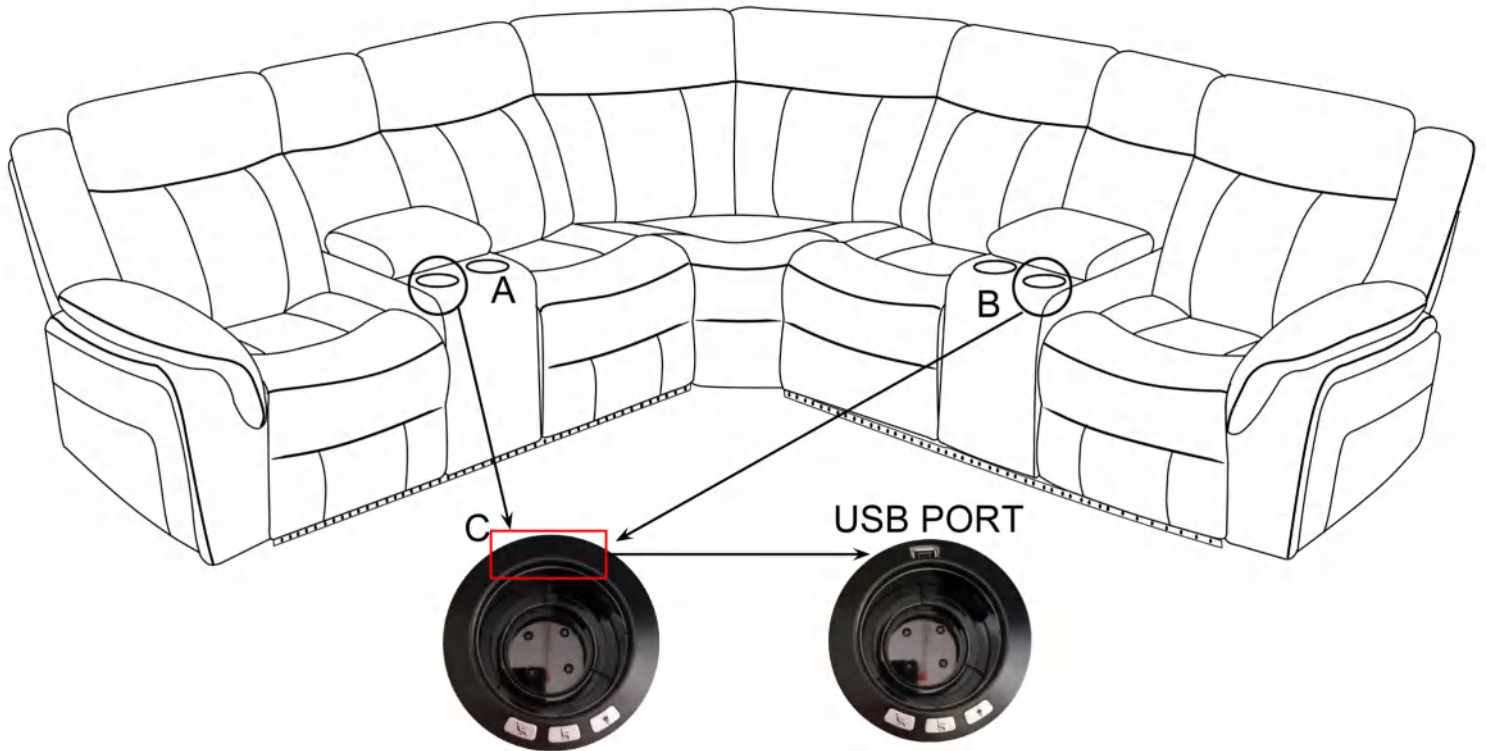

# OPERATING INSTRUCTION



- 1) Both A / B is cup holder controller.
- 2) Press  to recline the sofa, press  to return back.
- 3) Press  to turn the LED strip on and off.
- 4) Open the lid#C, there is a USB PORT for power charge.

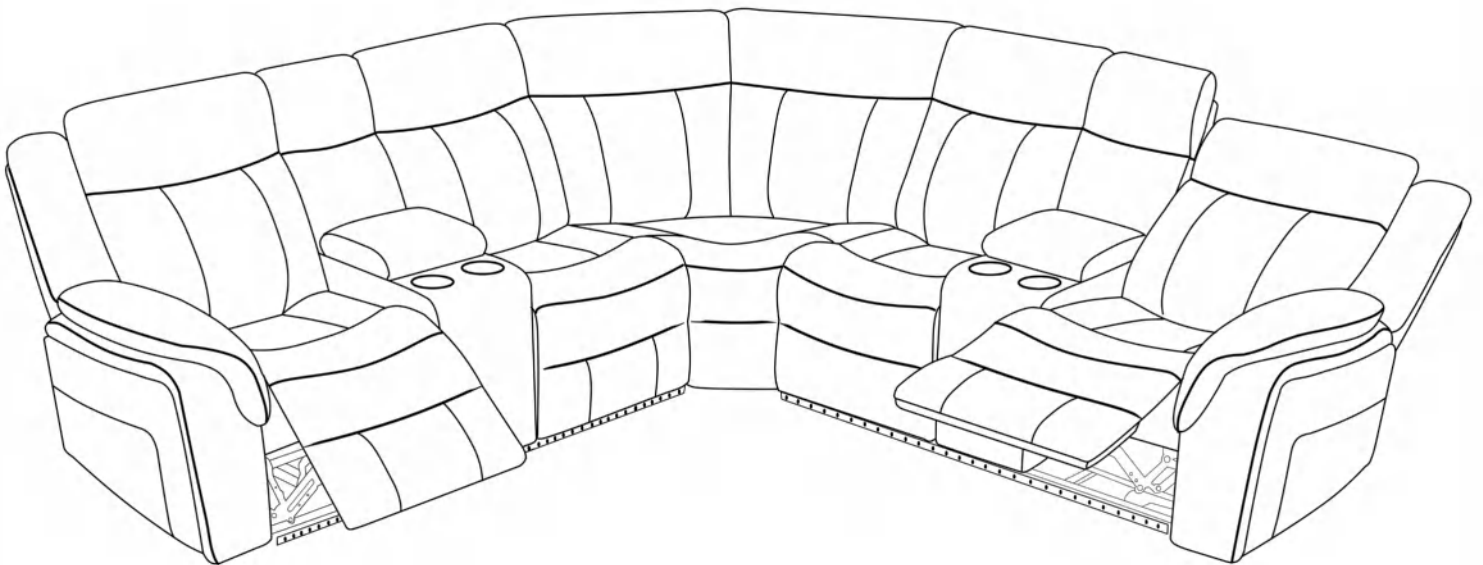

## Warnings

- 1) Sit down in the sofa gently. To avoid tipping over, do not throw yourself into the sofa. Move the sofa into the reclining position slowly, making sure that no children or pets are in close proximity. Do not allow children to play on or around the sofa, particularly when it is in an open position.
- 2) Close the recliner completely before getting out of it.
- 3) Never sit on the footrest when it is open, even if it is a child.
- 4) To eliminate the risk of tipping over, do not sit on the arms or footrest when it is open.
- 5) This sofa is designed to be used by 1 adult at a seating.
- 6) Maximum weight capacity is 300LBS, Do not allow any person who over 300LBS to sit on the recliner.
- 7) Please forbid people with the following ailments from using this sofa: Those people with severe symptoms of heart disease, high blood pressure, cerebral thrombosis and others who are sensitive to heat or completely insensitive to heat, those with brittle bones or have issues with waist support pregnant women, children and others where it has been determined they are not suitable to use this product under the guidance of doctors.
- 8) To fully recline the sofa, ensure the sofa well, you need to put the sofa at least 40cm away from the wall or any other obstacle.
- 9) Product cannot touch water, fire, etc. Product can also not come in contact with sharp objects (knives, nails, etc.)

## Maintenance Manual Instructions

- 1) To avoid dropping, you should carry the sofa carefully.
- 2) If you find dirt and or stains on the sofa, spray the sofa with a sofa specific cleaner then use a sponge or cloth to wipe the dirt away. Do not use water, soapy water or cleaner with waxed wooden areas. Take care to wipe the sofa carefully and gently.
- 3) Do not put the sofa in an area with direct sunlight and do not put the sofa directly in front of an air conditioner, this will fade the upholstery and make it brittle.

# How to Disassemble

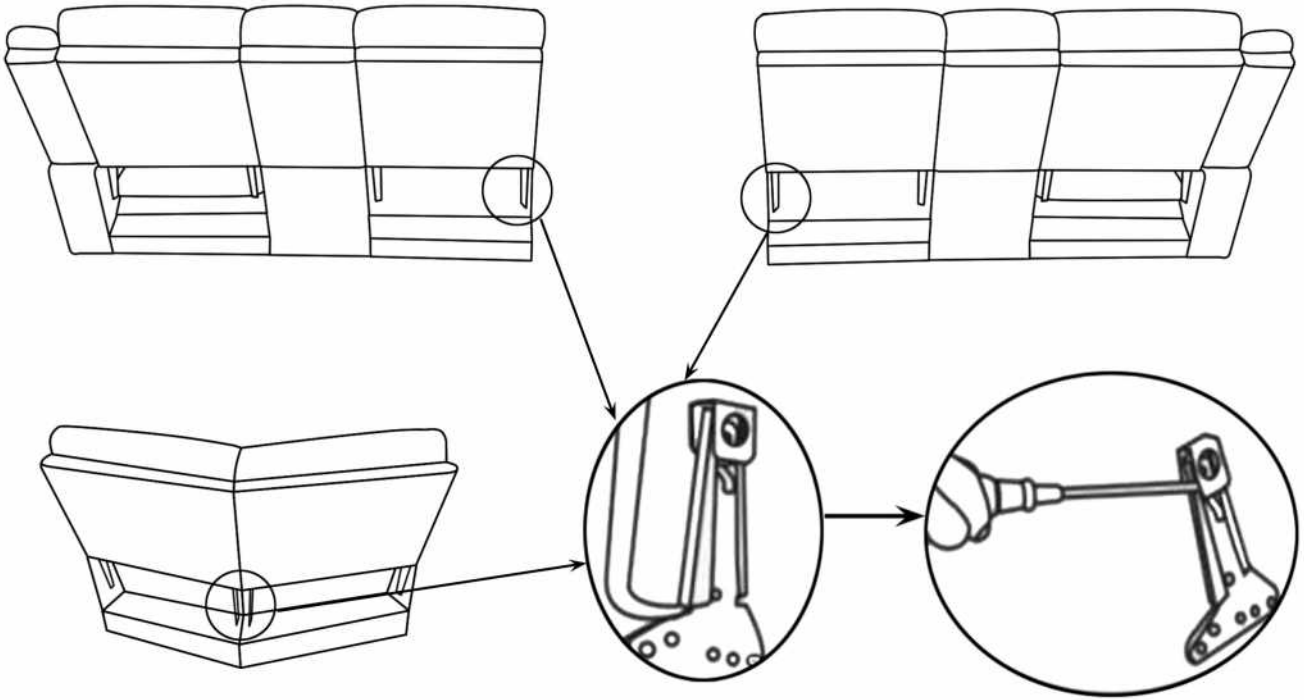

Please find a strong tool to prod the small piece of metal grooves, then the backrest will be pulled out.