

GeekSmart[®]

ROBOT VACUUM CLEANER

User Manual

Model No.: L8

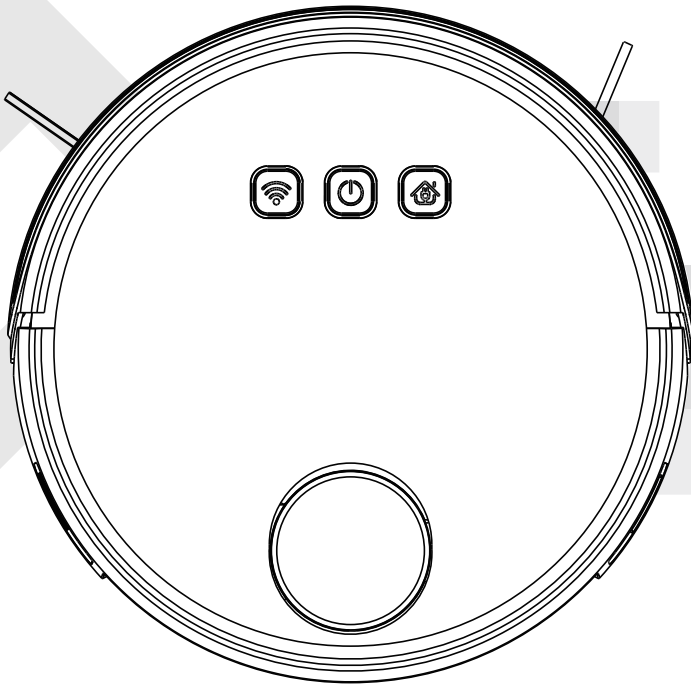

IMPORTANT: Read the instructions carefully before operating the appliance and keep them for future reference.

Safety Instructions	01
Product Components	03
How To Use	08
Cleaning And Maintenance	25
Troubleshooting	28

welcome

GeekSmart bids you welcome to a world of smart home devices, the robot vacuum cleaner. GeekSmart strives to explore and develop the smart home industry for the good of all by combining cutting-edge technologies to develop products fit and ready for the market. Please visit our website www.geektechnology.com.



Before use, please scan the QR codes to watch our easy step-by-step installation video. If you have questions regarding the installation process, please contact us by mail customercare@geektechnology.com or by phone **1-844-801-8880 / (862) 352-0406**.





Scan the QR code for more assistance and support

Important Safety Instructions

Please read the manual carefully before using the product and keep this instruction for reference.

1.  Products cannot be used by children under 8 years of age or people with mental disabilities. If these kinds of people need to use it, please do so under the supervision of the guardian. Please do not let children ride on the product or play with the product as a toy. Do not use the product in a room where infants sleep.
2. Issues that may arise in cleaning products should be eliminated as early as possible. Clean the power cords and small items on the floor to prevent the product from being blocked during the cleaning process. Fold the edge of the carpet to the underside of the carpet, and keep the hanging curtains, tablecloths, etc from touching the ground.
3. If there is a suspended environment such as a staircase, test the product first to see if it can detect the edge of the suspended area without falling. Protective barriers should be installed at the edge of the suspended area to prevent falling products. Make sure that the protective equipment does not cause personal injury.
4. Please follow the manual in the instructions to use the product. Use only accessories recommended or sold by the manufacturer.
5. Ensure that the power supply voltage meets the voltage indicated on the cradle.
6. Used only in indoor home environments. Do not use in outdoor, commercial or industrial locations.
7. Use only original rechargeable batteries and charging docks that are unique to the manufacturer. Do not use non-rechargeable batteries.
8. Ensure that dust boxes and filter materials are installed before using products.
9.  Using the product in an environment with open flames or fragile items is prohibited.
10. It is forbidden to get human's hair/clothes/fingers or other body parts close to the opening and operating parts of the product.
11.  Do not use the product on wet or watery ground.

12.  It is forbidden to absorb any items such as follows:
 - stones, waste paper.
 - flammable materials such as toner for printers or copies.
 - cigarettes, matches, ash, or other items that may cause a fire.
13. Do not place any product that is burning at the suction outlet. Do not use products when suction is blocked. Please clean the dust, cotton wool, hair, etc. at the suction port to ensure smooth air circulation at the suction port.
 Use the power cord carefully to avoid damage. Do not use the power cord to drag or pull the product. Do not use the power cord as a handle. Do not clamp the power cord into the door seam. Do not pull the power cord at sharp corners and corners.
14. Do not use the product if the power cord, power outlet or charging stand are damaged. Do not use the product when it is not working properly due to dropping, damage, outdoor use or water ingress. To avoid injury, the product should be repaired by the manufacturer or its after-sales service.
15. Turn off the product switch before cleaning and maintaining the product.
16. Before discarding the product, remove the product from the charge stand, turn off the product power switch, and remove the battery. Even if the product has been severely damaged, it is forbidden to incinerate the product, or the product battery may cause an explosion. Please dispose of used batteries in accordance with local laws and regulations.
17. If you do not use the product for a long time, please turn off the product.









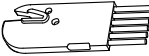

CAUTION

Immediately dispose of packaging as it can pose choking or other hazards to small children and pets. Please carefully confirm the consistency between the picture and the real components that correspond to the model you purchased.

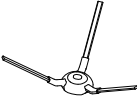
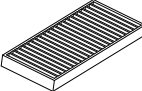
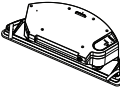
Product Components

What's in the Box

	Robot Vacuum X1
	Charging Base X1
	Clean Brush X1
	Power Adapter X1
	Side Brushes X6
	HEPA X2
	Water Tank X1
	Water Rag X1
	Remote Control "Optional" X2
	Instruction Manual X1

Assembly Name

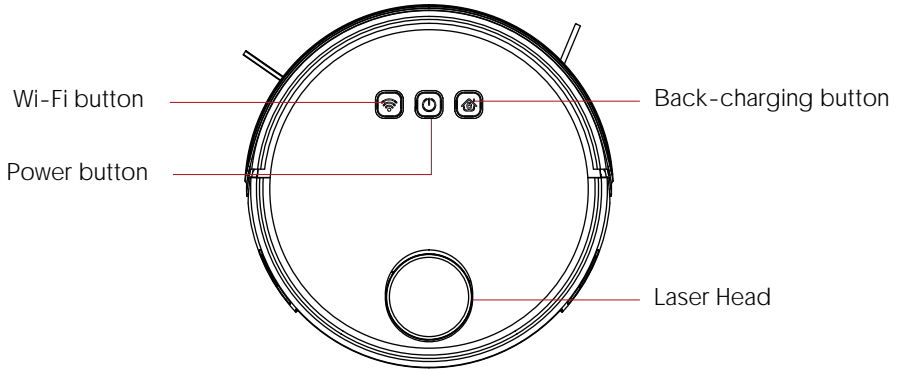

Top View

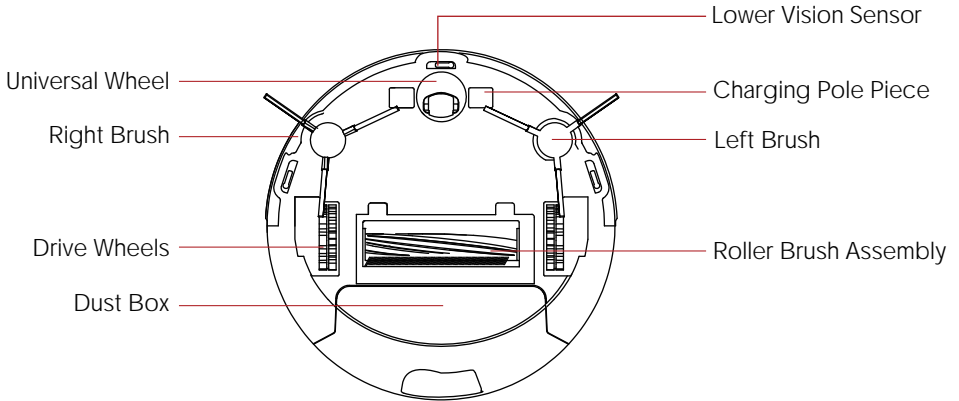

Bottom View

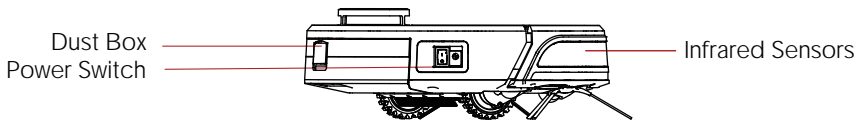

Side view

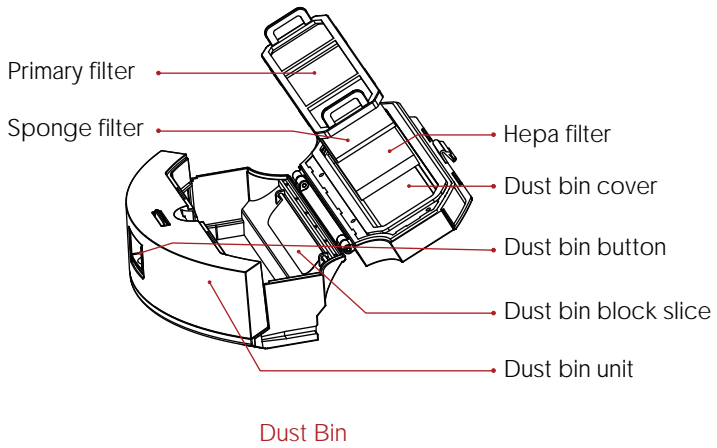
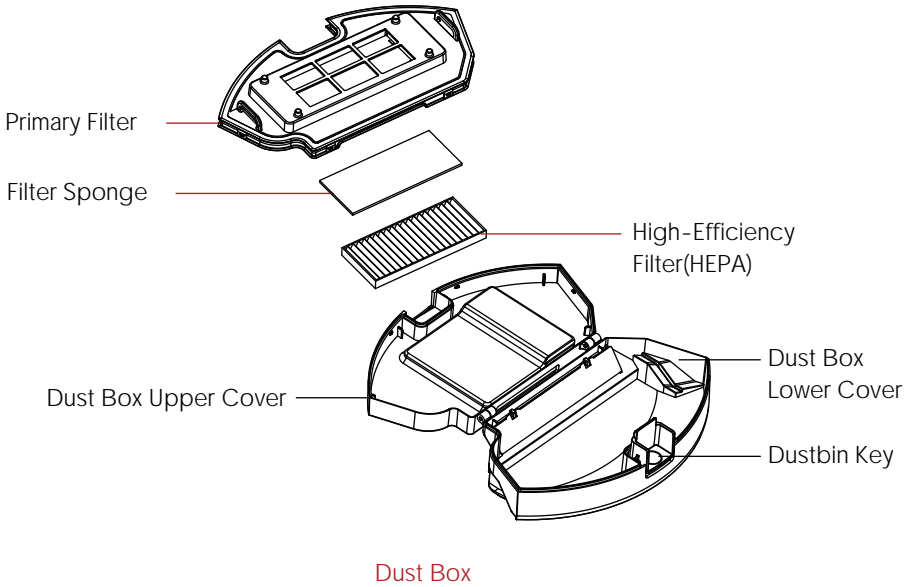

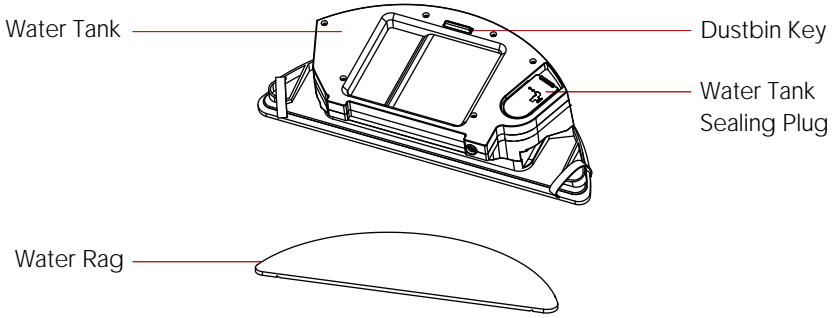

Water Permeable Rag Assembly

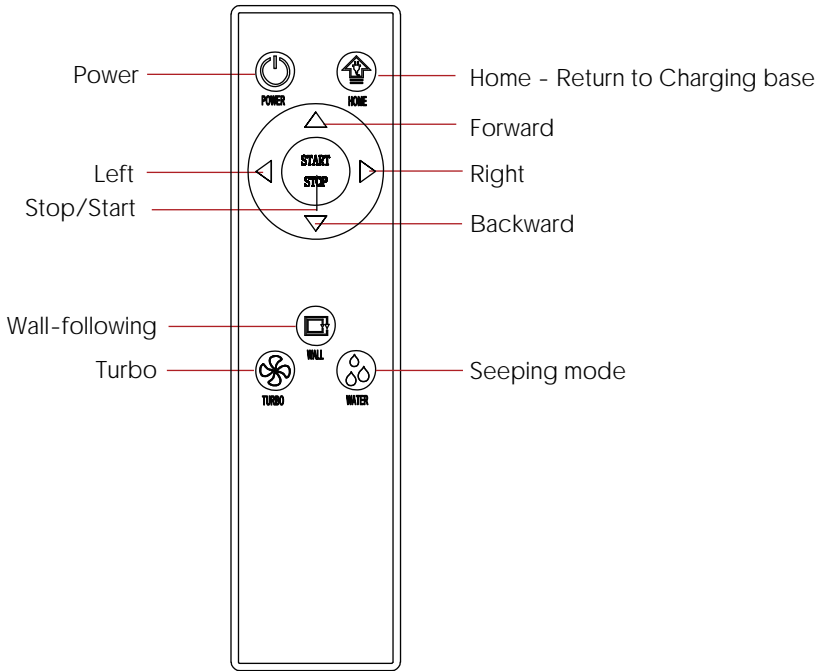

Remote Control ("Optional")

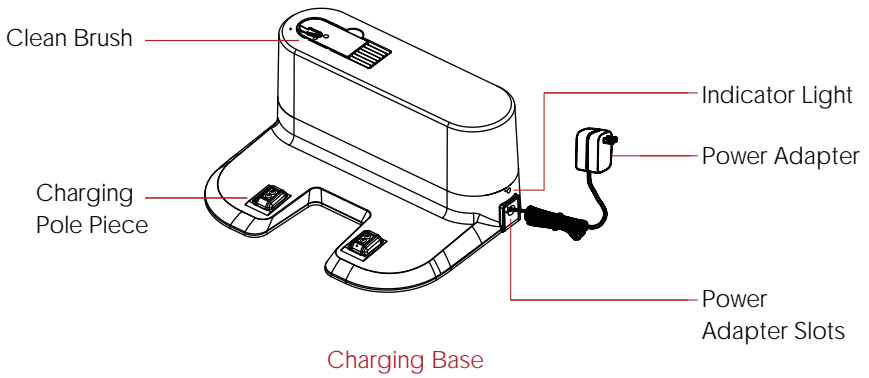

Charging Base

Parameter

	Product Model	L8
	Input	19V / 1A
	Power Consumption	30W
	Battery Capacity	Li-ion 3200mAh
	Dust Collector Capacity	0.5L
	Cleaning Time	Max. 110 mins
	Charging Time	Round 300 mins
	Battery	DC 3V(AAA)
	Remote Control Method	Infrared
	Emitting and Receiving Distance	5M
	Input	100-240V/50-60Hz
	Output	19V / 1A

Install two AAA batteries before using the remote control for the first time. Make sure the positive and negative ends are facing the correct polarity direction as marked in the battery compartment.

How To Use

Please refer to the following guidelines to check the cleaning area before the cleaner works.

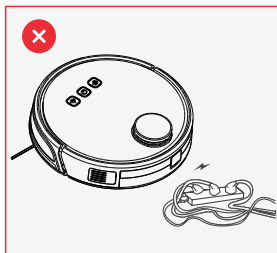

1. Power lines and other debris scattered on the ground may trip up the product, they must be removed.

2. Please roll the carpet tassels or let the product work on short-hair rugs.

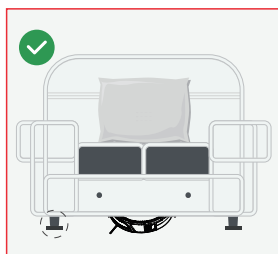
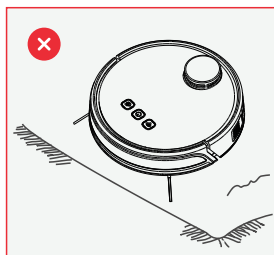

3. A gap of less than 8 cm on the bottom of the furniture may catch the product. If you need to clean it, please remove the furniture.

4. A guardrail should be placed at the edge of the duplex to ensure safe operation of the product.

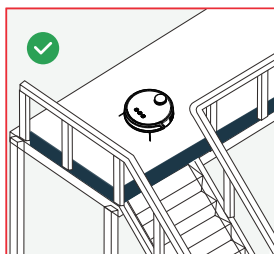

I ▶ Install The Side Brushes

Please install the right brush into the right bottom mounting port of the machine, the left brush into the left bottom mounting port of the machine, and ensure that the two side brushes are in place.

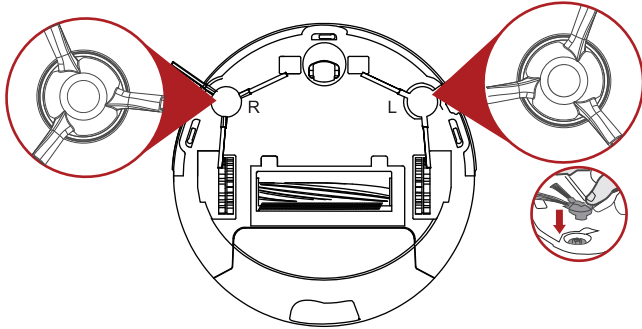

I ▶ Charging Operation

1. Place the charging stand flat against the wall. Do not place objects in the left and right 1M and the front 2M, and do not have objects with strong reflection surfaces such as mirrors.

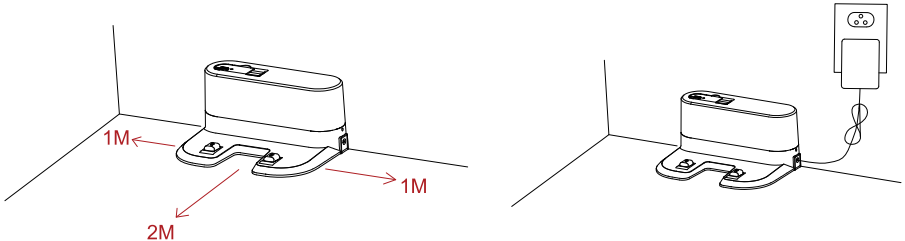

2. Turn on the side power switch, "I" is the turn, "O" is the turn off. After the finishes working, it is recommended not to shut down; keep the robot in a state of charge so that it can perform its next job better.

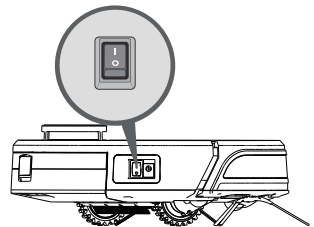

I ► Charging

3. Place the robot in the charging stand and pay attention to the charging pole piece. Turn on the power switch, the robot will enter standby mode.

⊗ The solid orange light indicates the appliance is returning for charging. The blinking orange light indicates the appliance is charging. The light will go off when it is fully charged.

⊙ The blue light indicates the appliance is working normally / fully charged. The blinking blue light indicates the appliance is ready to connect Wi-Fi.

📶 The solid blue light indicates the Wi-Fi is connected. For the first use, please charge continuously for more than 6 hours.

Please match the charging pole piece

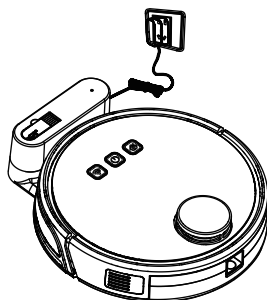

I ► Start/Stop Cleaning

1. Start or stop by pressing the robot's ⊙ key or the remote control's ⊙ / ▶| key.

NOTE: Before starting the mode, make sure that the outer ring of the ⊙ key is blue and the robot is in the state of being awakened.

If the robot does not wake up, short press the robot ⊙ to wake it up.

The robot enters the sleep state after 10 minutes of standby, and the ⊙ key light is off.

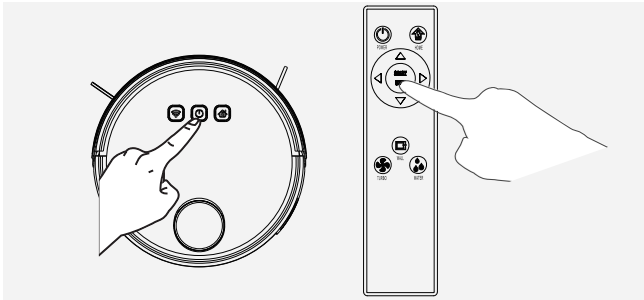

2. If you need to select another mode, please refer to the (Mode Selection) section.



▶ Mode Selection

In order to adapt to different ground conditions and achieve deep cleaning, this product has a variety of cleaning modes, which can be selected by remote control as needed.

The remote control can switch any mode directly.

Before starting the mode, make sure that the outer ring of the  key is blue and the robot is in the state of being awakened. If the robot does not wake up, short press the robot  to wake it up.

▶ Edge Mode

It is suitable for cleaning at the corners of the room. The robot is cleaned around the periphery of a fixed object (such as a wall) and cleaned back to the charging stand.

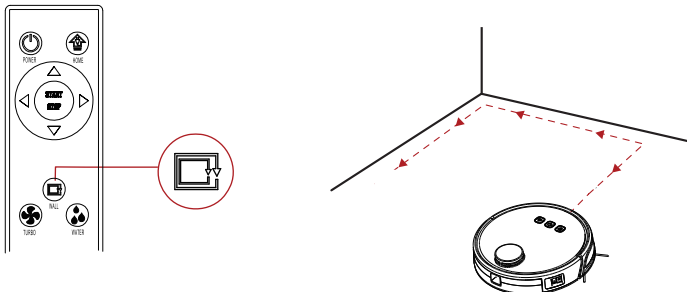

▶ Return Charging Mode

During the cleaning process, the robot can sense that its power is insufficient, and automatically find the charging stand for charging. You can press the “home” button or press the “power” button twice to make the robot return to the charging stand for charging.

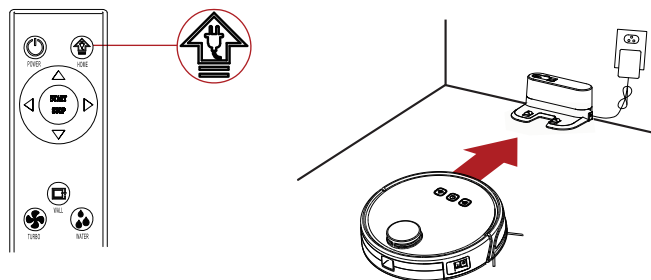

NOTE: In the regular cleaning mode, the maximum run time of the robot could be 100 minutes while it would automatically return charging for next task if it has completed present one.

▶ Suction Power Setting

Press the “Turbo” button on the remote controller, with two modes of suction power (strong / standard), standard mode can be used for daily cleaning while the strong mode would increase the suction power, standard mode for common household cleaning while the strong mode can be used for cleaning rugs.

▶ Seeping mode

Please press “water” button on the remote controller, with three modes to adjust water seeping speed. the first gear means low speed, the second gear means standard speed, the third gear mean fast speed. generally please select second gear.

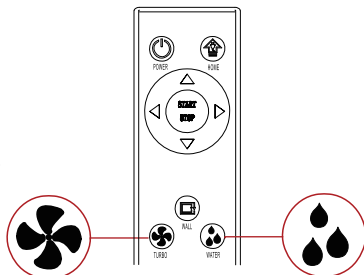

I ► Roller Brush Assembly and Cleaning

Remove the roller brush cover plate, remove the roller brush, cut off the hair wound on it and then use the cleaning brush to clean it.

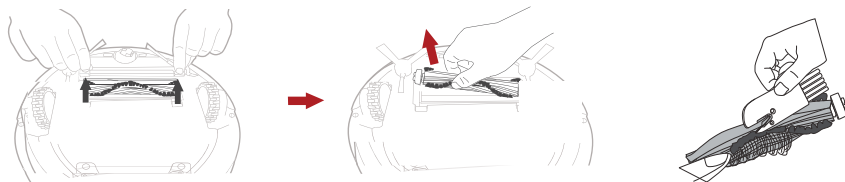

Set roller brush assembly: take out sucking assembly first, set the roller brush, cover the board and press it to lock.



I ► Use of Water Permeable Rag

1. This product is equipped with a water tank assembly. After the cleaning work is completed, if there is a demand for mopping, the dust box can be replaced with a water tank assembly. For the cleaning method, please refer to the [Maintenance] section in this manual.
2. Do not use the water tank assembly on the carpet. When cleaning with the rag function, fold the edge of the carpet to avoid foreign matter on the rag from soiling the carpet.
3. In the cleaning, please pay attention, add water or clean up in time, remove the water storage box when adding water when charging, be sure to remove the water permeable wiper assembly.

Add Water

Open the water inlet cover and take enough water.

STEP
02

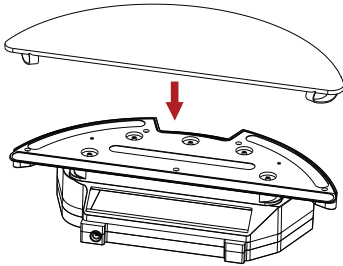

Install Water Tank Assembly

Press the dust box release button at the rear of the master to remove the dust box and replace the water tank assembly.

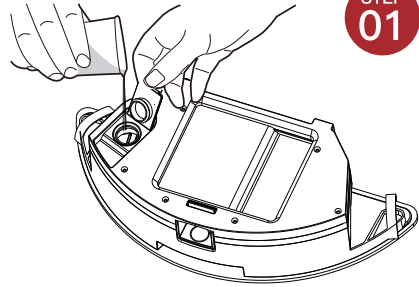

Sticking The Water Rag

Close the water inlet cover and stick the water rag.

STEP
03

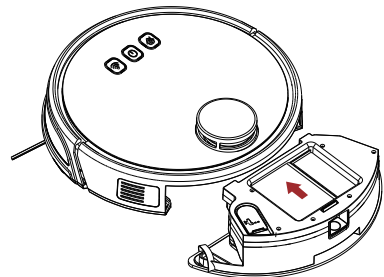

WiFi Connection

1. Please scan the QR code or search "GeekSmart" and download APP. After the APP is installed. Please follow the APP instruction to register the account and login.

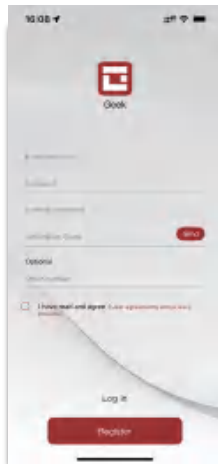

2. Open the APP, click **【add device】** or click the button **【+】** and select the "Robot Vacuum", then click the model you bought.

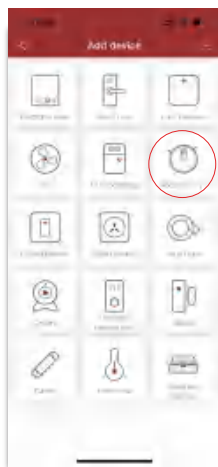



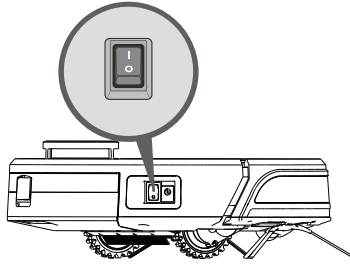



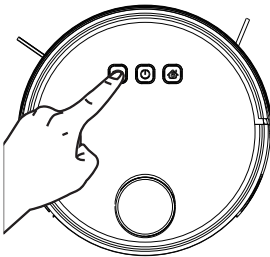

3. Please make sure that the product is on (like the picture shows)



4. Long press the button below for 3 seconds and then  flashes, input the wi-fi account and password.(only support 2.4Ghz wifi,5Ghz can not be connected.) A few seconds later ,the product will be connected to your phone.



I ► Description of App Icons and Buttons

	Icons and Descriptions
	Entire house cleaning: The vacuum cleaner generates a map of the entire house through sensor scanning, and automatically plans the optimal cleaning path.
	Where to sweep: You can specify a point on the app map. Then, the vacuum cleaner will automatically move to the point, and clean the 1.6mx1.6m zone centered on this point. You can click or drag on the map to set the target point.
	Selected zone cleaning: After the vacuum cleaner generates a map of the entire house, you can select one or more zones for cleaning through the app.
	Configured zone cleaning: You can configure a zone in a certain place on the app map. Then, the vacuum cleaner will automatically move to the zone for cleaning.
	Charging Base: When this icon is steady on, the vacuum cleaner automatically returns to the docking station for charging. When this icon blinks, the vacuum cleaner stops returning to the docking station.
	Set a forbidden zone for cleaning.
	Room edit: After the vacuum cleaner generates a map, you can combine different rooms or split room for cleaning etc. through APP.
	Setting: Including base function, and customized function.



I ► Power on and off the machine

Tap and hold the button to power on the machine. Then, the power indicator is on, and the vacuum cleaner enters the standby state. When the vacuum cleaner is in a static state, press and hold the button to power off the machine and stop the current cleaning task.

TIP: The vacuum cleaner in charging state cannot be powered off.

I ► Start cleaning

Press the  button to start cleaning. Then, the vacuum cleaner dynamically plans the cleaning route according to the map generated after scanning, and completes cleaning of different zones one by one. In each zone, the vacuum cleaner first sweeps the floor along the wall, and then moves in zigzag mode to clean the remaining part of the zone in an orderly and efficient manner.



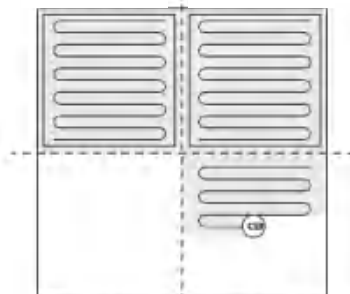

Zone 1: Cleaned Zone 2: Cleaned



Zone 4: To be cleaned Zone 3: Cleaning

- TIPS:**
1. If the power is too low, the vacuum cleaner cannot start cleaning. Therefore, charge the vacuum cleaner before starting it.
 2. Before cleaning, tidy up all kinds of wires on the ground (including the power cord of the docking station). Otherwise, the vacuum cleaner may drag the wires while cleaning, which may cause power failures of other electric appliance or damage to items or wires.
 3. If the cleaning area is less than 2 square meters, the vacuum cleaner will clean the area twice by default.
 4. If the power is insufficient in the cleaning process, the main unit will automatically return to the docking station for charging. After the power is sufficient, the main unit will automatically return to the interrupted point to continue cleaning (ensure that you have enabled the resumable cleaning function).

I ▶ Pause cleaning

If you need to add water to the water tank or wash the mopping cloth while the  vacuum cleaner is working, press the  button to pause. You can press the  button to continue cleaning, or press the  button in APP to return to the docking station and stop the current cleaning task.

TIP: In pause state, if the vacuum cleaner returns to the docking station for charging, the current cleaning task is stopped.

I ▶ Enter the sleep mode

If no operation is performed in 10 minutes, the vacuum cleaner automatically enters the sleep mode, and the power indicator blinks every several seconds. In sleep mode, you can press any button to wake up the vacuum cleaner.

TIPS: When the vacuum cleaner is being charged at the docking station, it cannot enter the sleep mode.

If the sleep time exceeds 12 hours, the vacuum cleaner automatically powers off.

I ▶ Charge the vacuum cleaner

Auto mode: After completing cleaning, the vacuum cleaner automatically returns to the docking station for charging.

Manual mode: In pause state, you can press the button to activate the "Return to docking station" mode.

When the vacuum cleaner is being charged, the power indicator blinks in breathing manner.

TIPS: If the vacuum cleaner fails to find the docking station, it automatically returns to the starting point. In this case, you need to manually put the vacuum cleaner back to the docking station.

I ▶ Faulty state

If the vacuum cleaner encounters a fault while working, the power indicator blinks quickly in red, and a voice prompt is generated. For details about troubleshooting method, see "Troubleshooting".

- TIPS:**
1. In faulty state, if no operation is performed in 10 minutes, the vacuum cleaner automatically enters the sleep mode.
 2. In faulty state, if the vacuum cleaner returns to the docking station for charging, the current cleaning task is stopped.

I ▶ Reset the Wi-Fi settings

If your mobile phone fails to connect to the vacuum cleaner due to reasons such as change of router settings and password forgotten, re-pair the vacuum cleaner with the mobile phone according to the Wi-Fi connection instructions.

TIPS: If the vacuum cleaner is in wait-to-connect state for more than 2 minutes, its Wi-Fi function is automatically disabled. To reconnect the vacuum cleaner to your mobile phone, reset the Wi-Fi settings.

I ▶ Where to sweep (Pin to go)

You can use the mobile app to specify a target point on the map. The vacuum cleaner will automatically plan the route and move to the specified point. If you specify a target point in the app when the vacuum cleaner is in standby or pause state, the vacuum cleaner will clean the square zone centered on this point. After cleaning, the vacuum cleaner will automatically return to the starting point and stop working.

TIPS: If the vacuum cleaner fails to find the docking station, it automatically returns to the starting point. In this case, you need to manually put the vacuum cleaner back to the docking station.

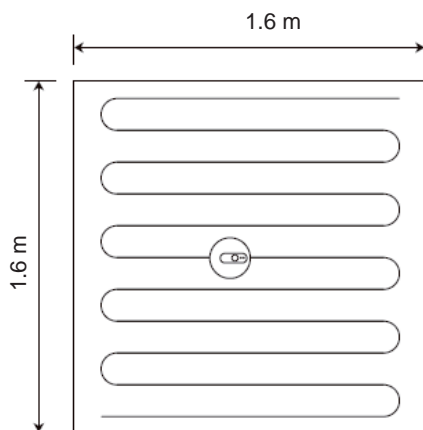

▶ Set a restricted zone (area in App) or virtual wall (Awall in App)

You can use the mobile app to set a restricted zone or virtual wall. After the setting is completed, the vacuum cleaner will not enter the restricted zone or cross the virtual wall for cleaning.

TIP: The functions and details of the app may change slightly due to continuous development and upgrade of the app. The specific functions and details of the app are subject to the actual version.

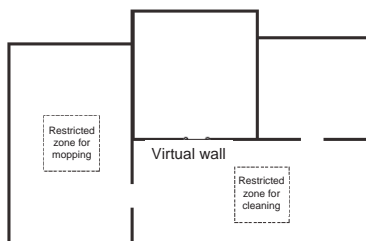
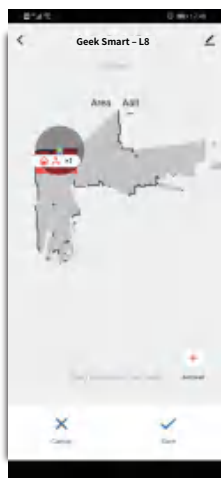

- TIPS:**
1. Before using this function, you need to enable the map save mode for the vacuum cleaner in the mobile app.
 2. This function is only used to divide cleaning zones, but cannot be used to block dangerous zones.
 3. If the vacuum cleaner is moved or there are significant changes in the the home environment, the map may become invalid and the settings of virtual wall or restricted zone may be lost.

I ► More function for choice in setting

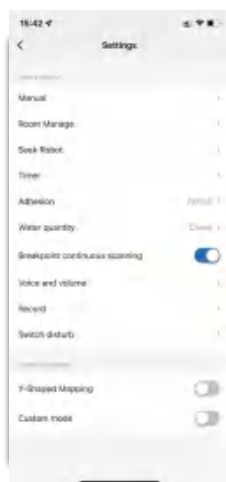

1. Manual

Including Forward Backward left right four direction button.



2. Room manager

You can use the mobile app to select one or more zones for cleaning. The vacuum cleaner will clean one or more rooms based on the zone that you select on the app map.

- TIPS:** 1. Before using this function, you need to enable the map save mode for the vacuum cleaner in the mobile app, and the vacuum cleaner has already generated a map for cleaning.
2. After cleaning starts, the main unit may move to a place beyond the selected zone. Make sure that you have cleared the obstacles on the ground around the selected zone, which cannot be used for safety isolation.

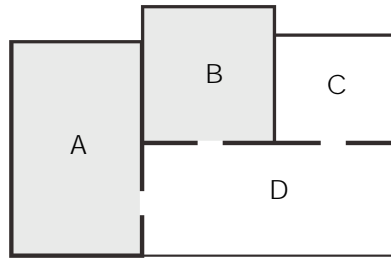

3. Seek robot: find where the robot.

4. Timer

You can use the mobile app to set the scheduled cleaning time. When the specified time arrives, the vacuum cleaner will automatically start cleaning, and return to the docking station after it completes cleaning.



5. Adhesion: adjust suction power.

6. Water quantity: adjust water seep when mopping.

7. Breakpoint continuous scanning:

If low power, the cleaner will be back to charging base to charge, then back to the breakpoint to clean continuously.

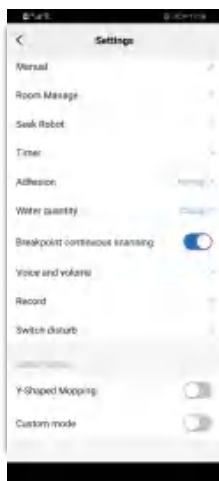

8. Voice and volume

9. Record: cleaning record.

10. Switch disturb: choose time for robot when don't need work.

Cleaning And Maintenance

Dust Box and Filter

When cleaning and maintaining the robot and its accessories, turn off the robot and unplug the charging stand.

1. Remove the dust box, open the dust box cover, and clean the garbage.
2. Remove dust filter. HEPA is not recommended for washing. Please pat and remove ash.
3. Flush the dust box and the primary filter.
4. Dry the dust box and the dust filter assembly and keep it dry to ensure its service life.

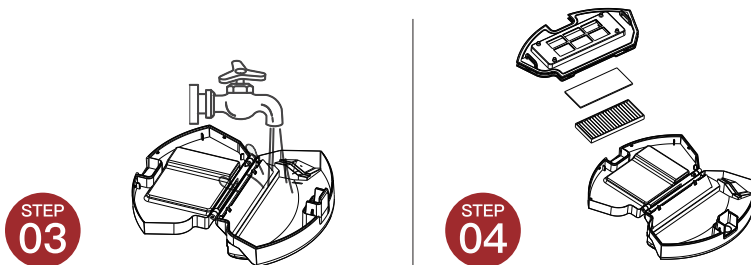
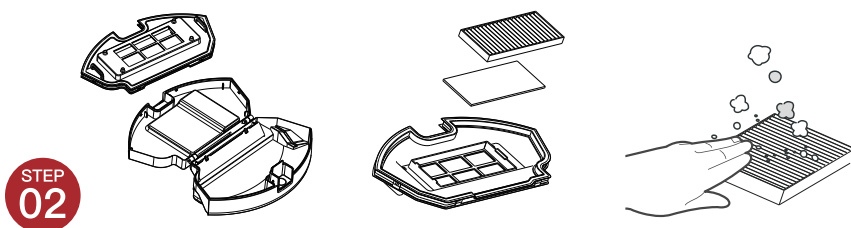
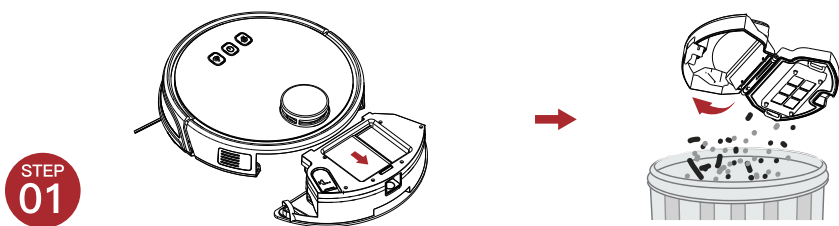

Please let these parts dry naturally for more than 24 hours.

I ► Cleaning of Water Rag

1. Remove: After the mopping is completed, remove the water tank assembly and remove the water permeable rag.
2. Maintenance: Rinse and dry the water rag.
3. Remove: After mopping the floor, remove the water tank assembly, remove the water permeable cloth, and pour off the remaining water in the water reservoir.

STEP
01

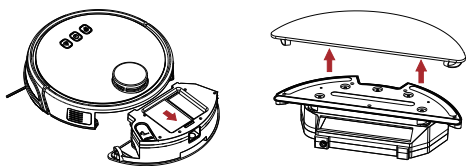

STEP
02

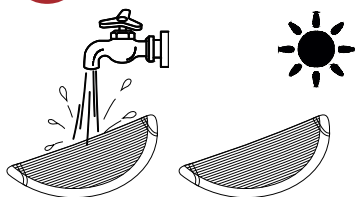

STEP
03



Maintenance: Dry the reservoir and allow it to dry.

I ► Cleaning of Water Rag

Pull out the side brush and wipe it with a clean rag.

I ► Other Assembly

Cleaning the universal wheel to reduce hair entangle.

Clear down the sensor to ensure the sensitivity of the sensor.

To clean the charging pole pieces, use a dry rag to clean the charging poles on the bottom of the robot or the charging stand.

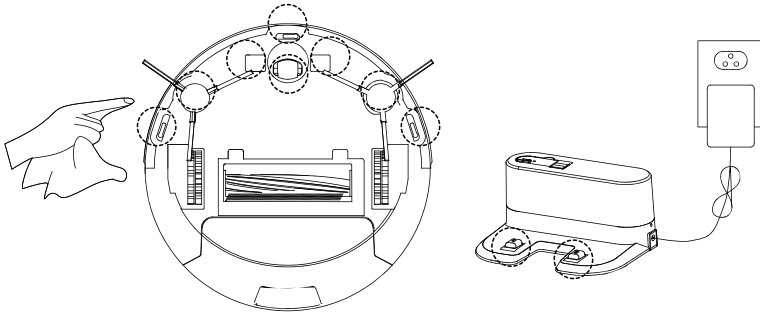

If you will not use the product for a long time, please remove the battery and keep it in a safe place. If the battery leaks, remove the battery and wipe the battery compartment clean.

This product uses a high-life battery and does not require frequent replacement. If you need to replace, you can contact our company for after-sales service replacement.

Troubleshooting

Cause of Issue	APP content	Solution
Left wheel error	Left Wheel Fault	Put the wheel on the ground
Collision buffer stucked	Collision Buffer Is Stuck	Push heavily the front bumper, the check whether the front bumper can bounces back
No water tank inside	The Water Tank Is Not Installed	Please install the water tank correctly
Ground sensor error	Ground Sensor Abnormal	Clean the ground detector and make sure I'm not lift up
Robot not on the gound	The Host Is Picked Up	Put the robot on the ground
Robot trapped	The Host Is Trapped	Please take robot to open space
Laser head stucked	The Upper Cover Of The Laser Head Is Stuck	Don't cover over the laser head
Laser sensor not work	Laser Sensor Error	Clean the laser sensor and make sure not covered
Laser sensor covered	Laser Sensor Is Covered	Don't cover over the laser sensor
Robot stucked	Unable To Leave The Restricted Area	Please help the robot manually

FAQs

Please install the right brush into the right bottom mounting port of the machine, the left brush into the left bottom mounting port of the machine, and ensure that the two side brushes are in place.

Q : What should I do when it can not work on the carpet?

A : We don't suggest you make it clean the carpet. It's better to stick some boundary strips around the carpet as no-go zone.

Q : What if the strength of vacuuming is weak?

A : First of all, check whether the dust bin is full and the robot is fully charged. If it does, you can try to switch it to the higher mode. For litter which is difficult to collect, try to clean it with Spot Cleaning Mode.

Q : What if my charger has difficulty charging the robot?

A : Please make sure you turn on the charging stand before charging and check if the electrical sheet is connected to the charging stand (Put it back manually or press the Power button when the robot is 1 meter in front of the charging stand.)

Q : What if the robot can not find the charging stand?

A : The charging stand should be placed against the wall with at least 1 meter clearance each side and 2 meters in front. Sometimes you can just put it back manually.

Q : What should I do if the remote control is out of order?

- A :**
1. The remote control has an effective control distance of 5 meters. Please make sure that the remote points to the master.
 2. Replace the battery with a new one if the battery has run out of capacity.
 3. Please make sure the master power switch is turned on and has sufficient power to complete the operation.
 4. Please wipe the infrared emitter of the remote control and the infrared receiver of the master with a clean towel.

Q : Why does the master return to charging after cleaning?

A : The working time of the master varies depending on the complexity of the room, the amount of garbage and the cleaning mode.