

Assembly Instructions

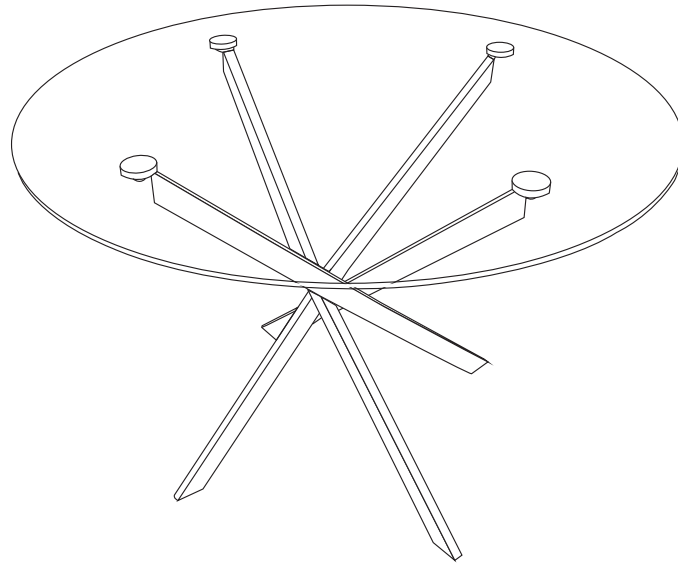







Caution:Pls read the AI before you proceed.



CAUTION:





Pls follow up the AI , when assemble the table leave your child away

Parts List

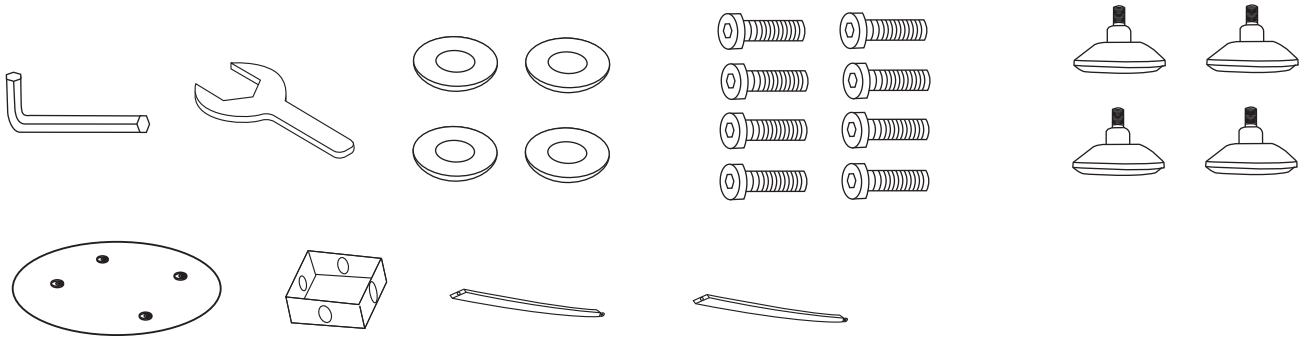
NO.	Picture	Description	Qty
A		Glass	1
B	 8X8mm	Screw	8
C	 80X80mm	Iron Box	1
D	 8X16mm	Gasket	4
E	 13X30mm	Adjwstable foot corner	4
F	 6X30X85	Allen key	1
G	 75X20mm	Spanney	1
H	 20X40X930mm	Legs	4

Assembly Preparation Before Beginning Assembly



-  • Read instructions, cover to cover-
-  • Have 2 adults on hand for assembly-
-  • Do not assemble on flooring or carpet-
-  • Assemble on a clean non- marring surface (packing foam)-
-  • Save all packaging until finished-

Step 1

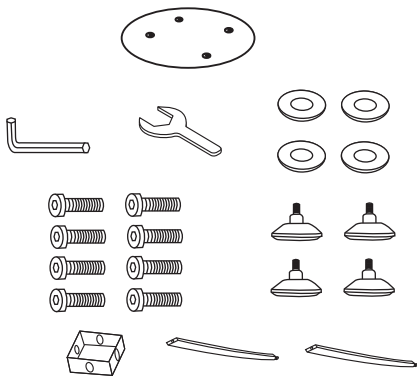

Unpack and place all parts on a clean , soft surface

Step 2

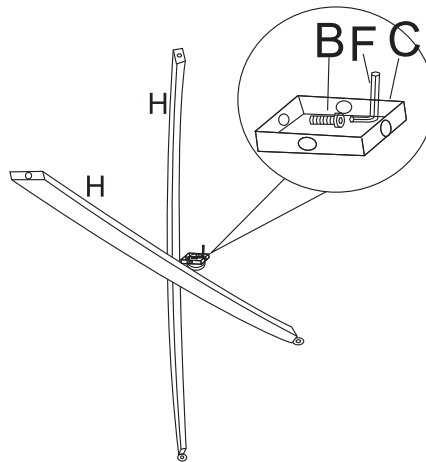

Step 3

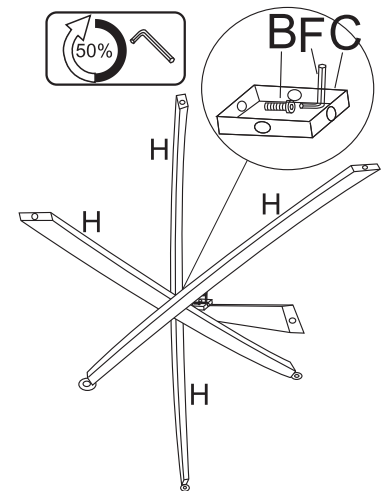

Step 4

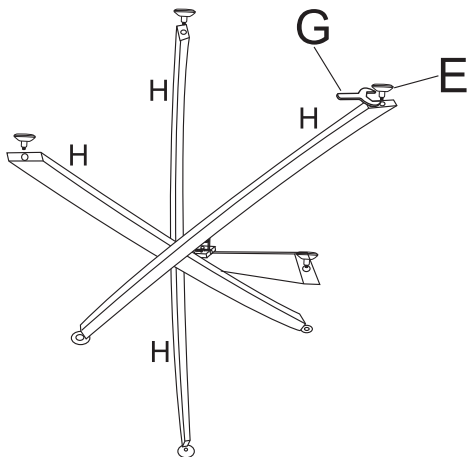

Step 5

